



CINEMA BD100

Home Theater System









QUICK-START GUIDE

THANK YOU FOR CHOOSING A JBL® PRODUCT!

This quick-start guide contains all the information you need to connect and set up your new JBL Cinema BD100 home theater system.

To conserve our natural resources, your home theater system does not include a printed owner's manual. An owner's manual containing complete information about operating all of your new home theater system's features is available at our Web site. Go to www.jbl.com and download the *Cinema BD100 Home Theater System Owner's Manual*.

Your Cinema BD100 system is designed to be compatible with region management information that is encoded on most Blu-ray Disc and DVD recordings. Your system will only play discs that contain region coding for the area where your system was shipped and intended for sale:

AREA WHERE SOLD	BLU-RAY DISC REGION CODE	DVD REGION CODE
USA, Canada		
Europe, Middle East		
Japan		
Korea, S.E. Asia		
Mexico, Latin America		
Australia, New Zealand		
Russia, India		
China		

For example, Cinema BD100 systems shipped to and sold in the USA will only play Blu-ray Discs that contain region code A and DVD discs that contain region code 1.

CONNECTIONS

CONNECT THE SPEAKERS

CAUTION: Before making any connections to the BD100 receiver, ensure that the receiver's AC cord is unplugged from the receiver and the AC outlet. Making speaker connections with the receiver plugged in and turned on could damage your speakers.

Your Cinema BD100 receiver has color-coded speaker connectors and the Cinema BD100 speaker wires are color-coded to make it easy to properly connect the speakers.

white	front left (+)
red	front right (+)
blue	surround left (+)
gray	surround right (+)
green	center (+)
purple	subwoofer (+)
black	(-) on all speakers

Connect the speaker's wire with the colored band to the receiver's speaker terminal with the same color. Connect the speaker's black wire to the black receiver speaker terminal directly under the colored terminal.

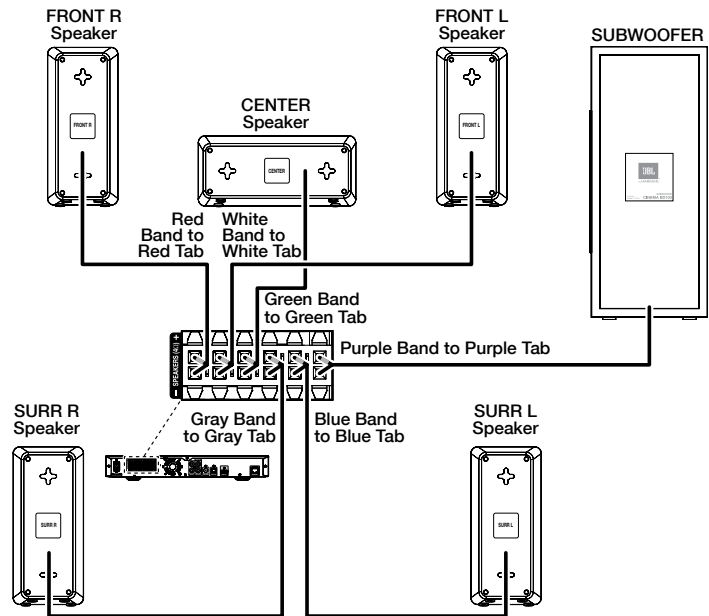

IMPORTANT: Make sure the (+) and (-) bare wires do not touch each other or any metal object on the receiver's rear panel. Touching wires can cause a short circuit that can damage the BD100 receiver.

PLACE THE SPEAKERS

Place the speakers and subwoofer according to the illustration below.

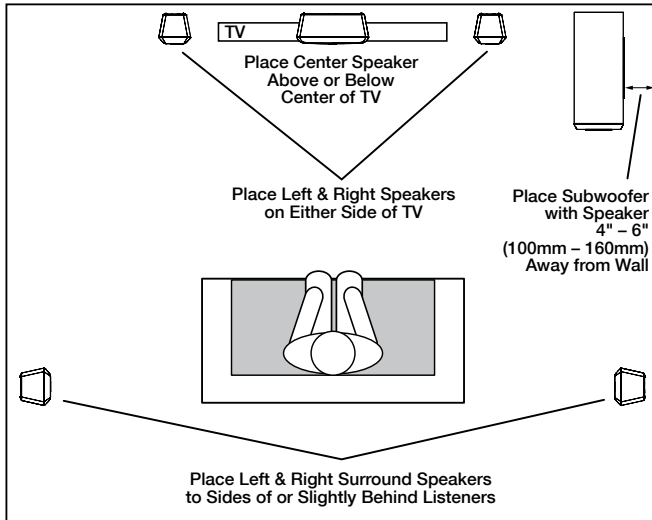

- You can mount the left, right, center and surround speakers on the wall using picture hanger hardware.
- Placing the subwoofer with its speaker 4" – 6" (100mm – 160mm) from a wall maximizes bass performance and helps protect the exposed speaker unit from accidental damage.

For more detailed speaker placement information, please go to www.jbl.com and download the *Cinema BD100 Home Theater System Owner's Manual*.

CONNECT THE RADIO ANTENNA

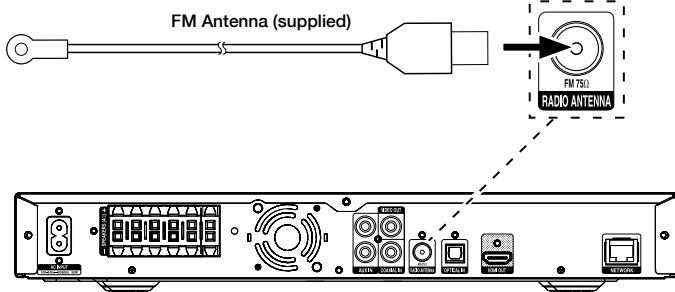

CONNECT A TV OR VIDEO DISPLAY

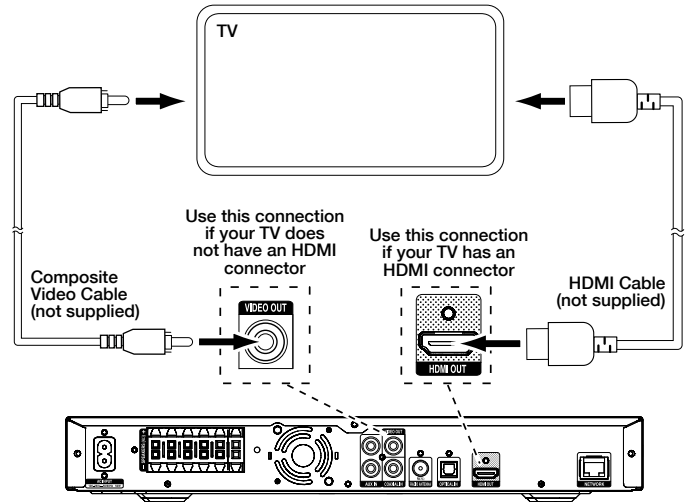

NOTE: If your TV supports the HDMI Audio Return Channel and you access digital TV channels from your TV's built-in tuner or you have other sources already connected directly to your TV, you can feed their sound to the Cinema BD100 system via the HDMI Out connector's Audio Return Channel, and they will not require additional connections to the receiver.

CONNECT TO YOUR WIRED HOME NETWORK

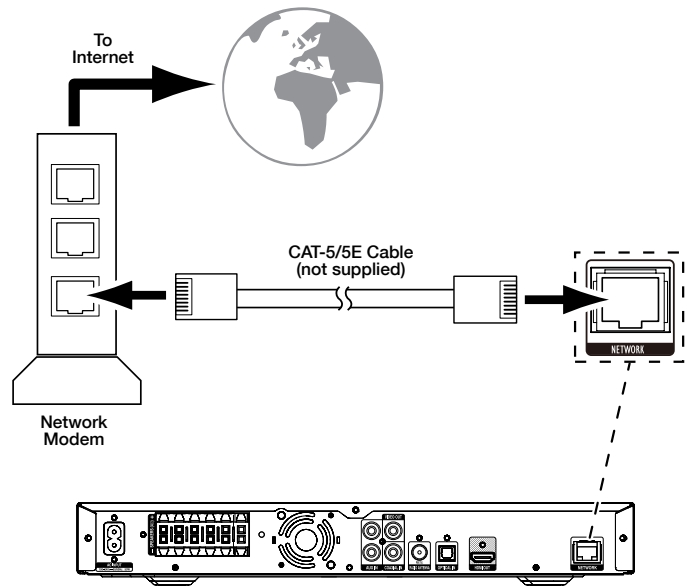

NOTE: Download the *Cinema BD100 Home Theater System Owner's Manual* from www.jbl.com and refer to the Setting Up the Receiver section for information about joining the receiver with your network.

CONNECTING YOUR OPTICAL DIGITAL AUDIO SOURCE DEVICE

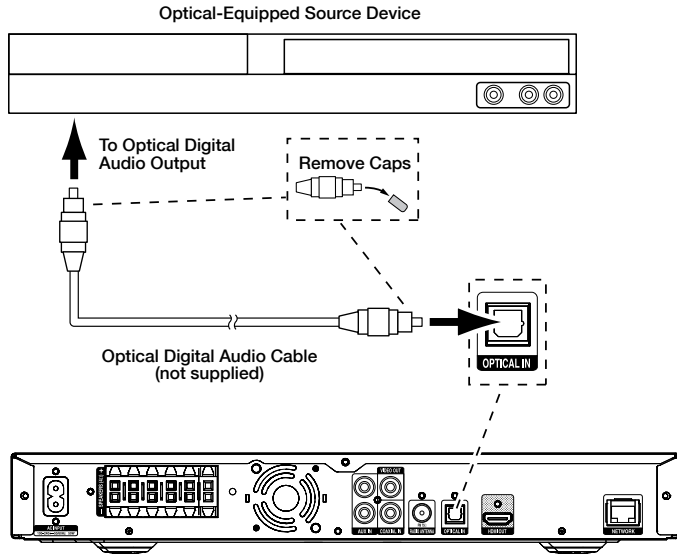

CONNECTING YOUR ANALOG AUDIO SOURCE DEVICE

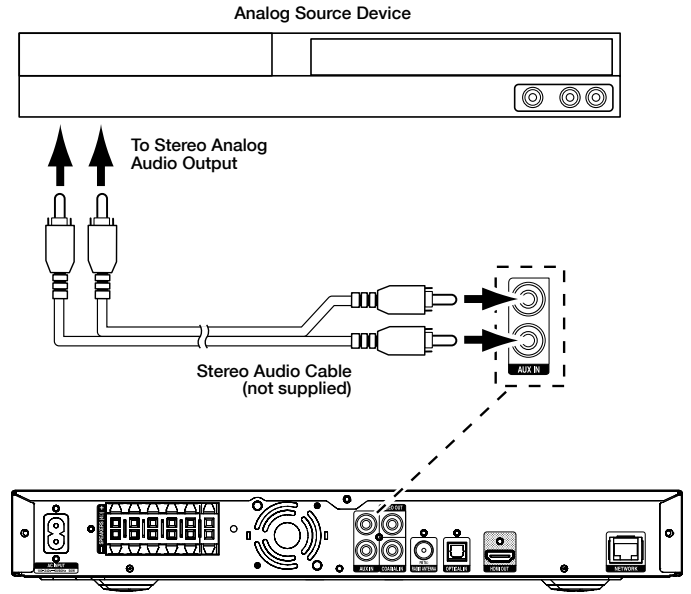

CONNECTING YOUR COAXIAL DIGITAL AUDIO SOURCE DEVICE

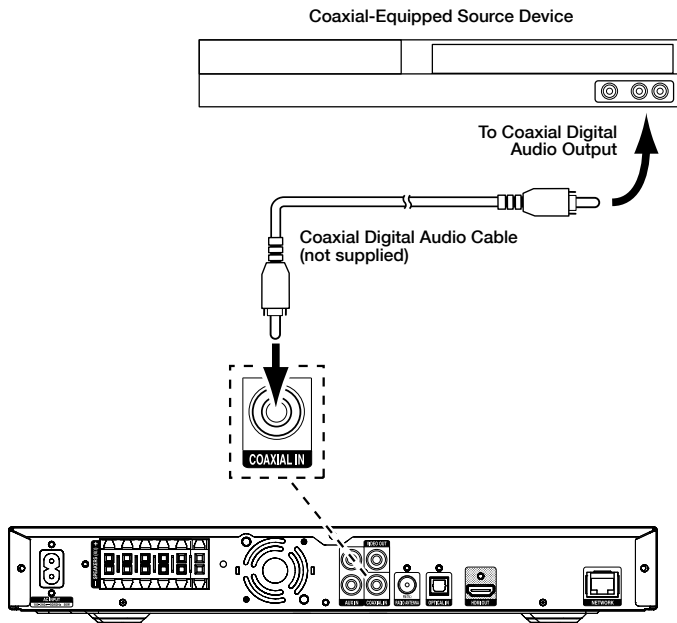

CONNECT THE AC POWER

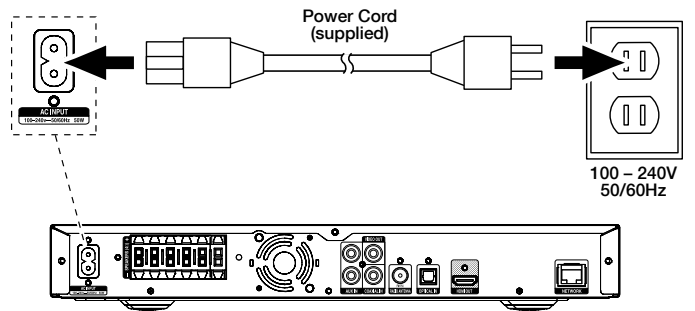

SET UP THE RECEIVER

INSTALL THE BATTERIES IN THE REMOTE CONTROL

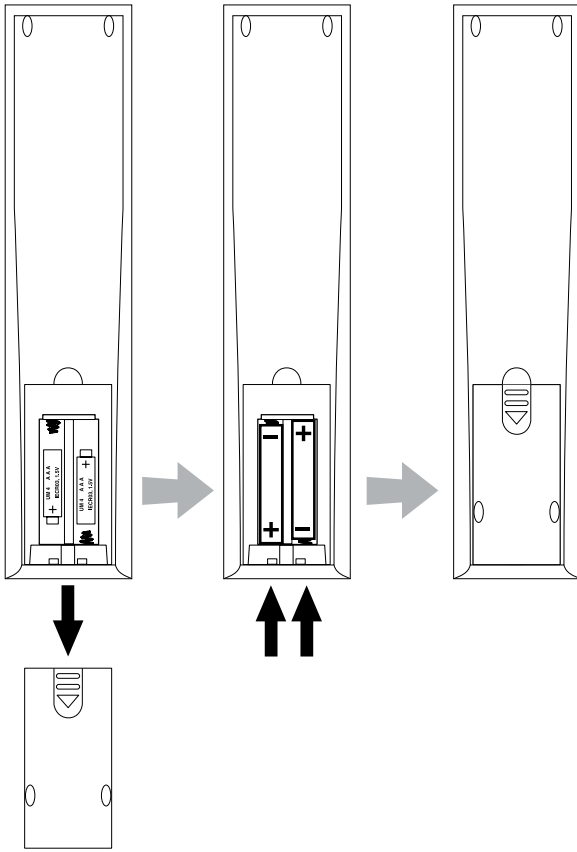

TURN ON THE RECEIVER

Press the receiver's Power button to turn it on.

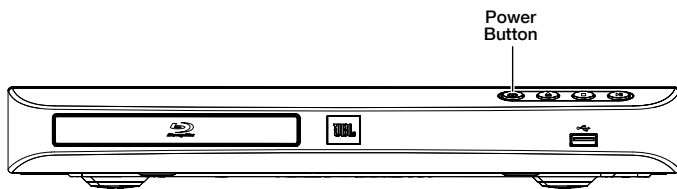

To set up your BD100 receiver you will use the remote to navigate through the on-screen menus and to make selections from them.

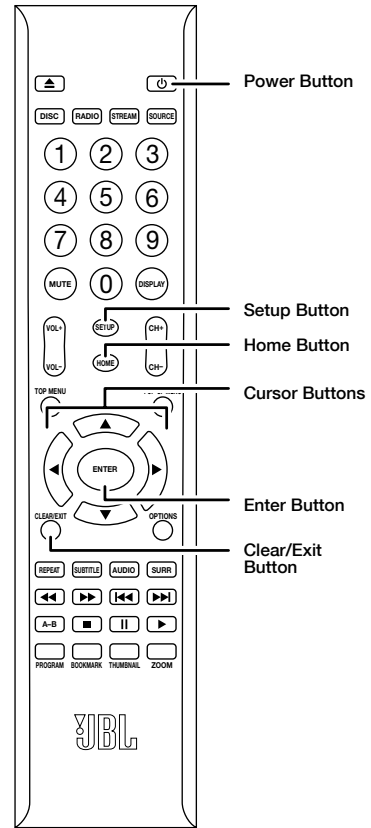

- Use the Cursor Up/Down buttons to navigate through the menu list. To select a highlighted item, press the Enter button. The screen will change depending on your selection.
- To return to the previous screen, press the Cursor Left button.

SETUP WIZARD

When you turn your BD100 receiver on for the first time, the on-screen menu will display the Setup Wizard introduction screen.

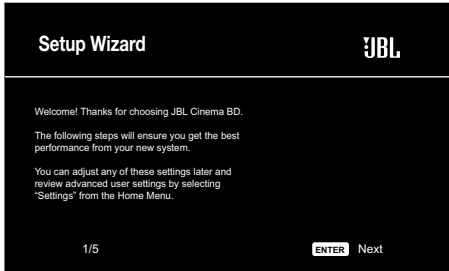

Press the Enter button, and the language selection screen will appear.



After selecting the language you want the BD100 receiver to use, press the Enter button, and the Initial Setup TV resolution screen will appear.

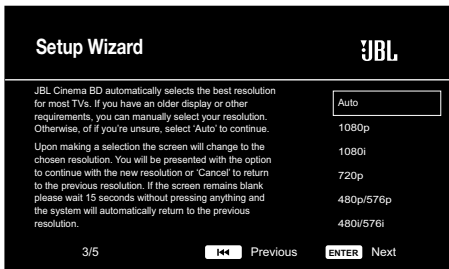

After selecting your TV's resolution, press the Enter button, and the Initial Setup aspect-ratio screen will appear.

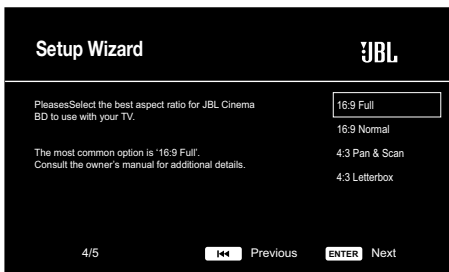

After selecting the aspect ratio that best fits your TV, press the Enter button to save your settings and then press it again to exit the Setup Wizard screens.

SET THE SPEAKER DISTANCES

Before you use your Cinema BD100 system you need to enter the distance from each speaker to your listening position. When you installed your Cinema BD100 system, you may have had to place some speakers a little farther away from the listening position than others. Sounds that are supposed to arrive simultaneously from different speakers may blur, due to different arrival times. The BD100 receiver provides an adjustment that compensates for these real-world speaker placement differences, so your Cinema BD100 system can deliver a superior surround-sound experience. (Even if all your speakers are the same distance from the listening position you still need to enter their distances.)

1. Measure the distance from each speaker (except the subwoofer) to your main listening position. Write the distances down.
2. Press the remote's Setup button. The General Settings menu will appear.

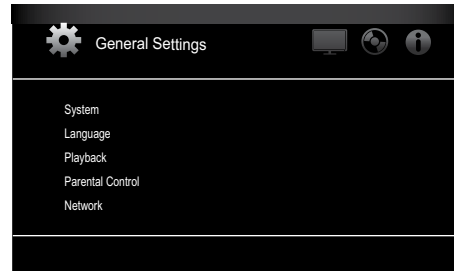

3. Use the right Cursor button to select Audio Settings, then use the down Cursor button to select Speaker Settings. The Speaker Settings screen will appear.

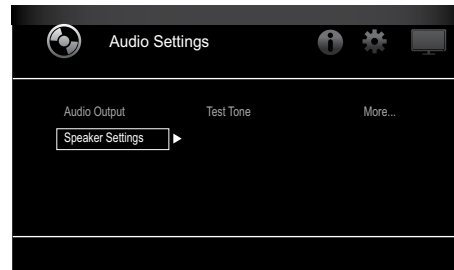

4. Press the right Cursor button to select Test Tone, then press it again to select More... The Speaker Settings screen will appear and you will hear test noise circulate through each speaker in turn. The active speaker will be highlighted on the screen. (Use the remote's Volume – button to lower the volume if the test noise is too loud.)

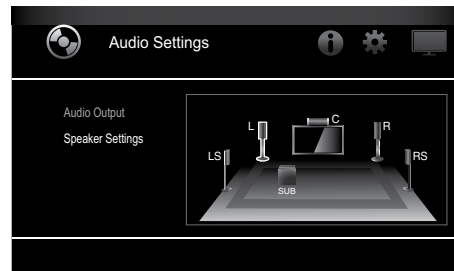

5. Press the Enter button when the speaker you want to adjust is highlighted. The Level and Distance adjustment selections for that speaker will appear.

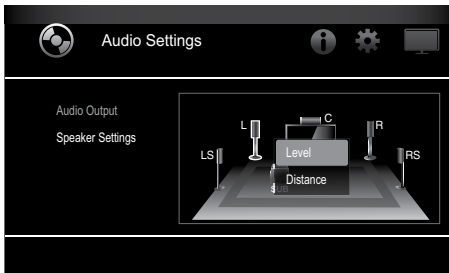

6. Press the down Cursor button to highlight Distance, then press the Enter button to select it. The speaker's distance adjustment will appear. Note: You do not need to adjust the individual speaker levels at this time.

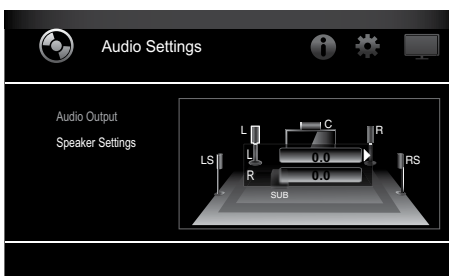

7. Use the right Cursor button to set the distance you measured for that speaker. (The distances show in meters. Each .3 meters equals 1 foot).

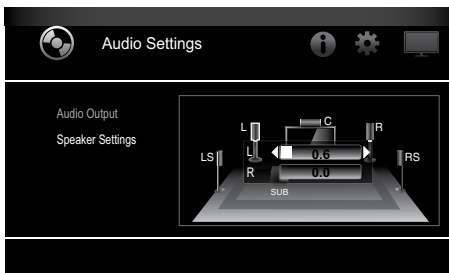

8. Repeat steps 5 – 7 for each speaker in the system (except the subwoofer). To return to the previous menu screen, press the Clear/Exit button.
9. When you have set the distances for all the speakers, press the Setup button to exit the setup menu.

For complete information about all of your Cinema BD100 system's settings and adjustments, download the *Cinema BD100 Home Theater System Owner's Manual* from www.jbl.com.

USING THE BD100 RECEIVER

Press the remote's Home button to display the Home Menu screen:

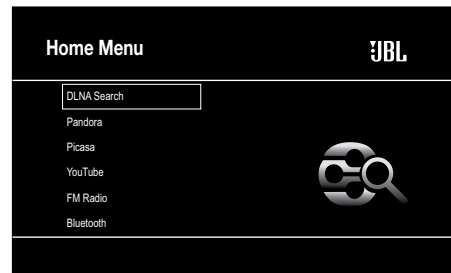

The available sources are listed on the left. If a disc has been inserted into the receiver's built-in disc slot, it will appear on the list as "Blu-ray Disc," "DVD Video," "CDDA" or "Data Disc" (audio or data CD-R disc). If you have inserted a USB device into the receiver's USB port, it will appear on the list as "USB."

The "Input" source displays a screen that lets you access digital and analog sources you connected to the receiver's rear-panel optical digital and analog inputs, as well as the HDMI Audio Return Channel.

To select a source from the list, use the Cursor Up/Down buttons to highlight the desired source, then press the Enter button to select it.

You can also select sources by pressing the four Source Selector buttons on the remote. Repeatedly press the "Stream" button to access available streaming services and *Bluetooth*. (Different streaming services are available in different regions. See the *Cinema BD100 Home Theater System Owner's Manual* for details.) Repeatedly press the "Source" button to access audio sources you connected to the receiver's rear-panel connectors and the HDMI Audio Return channel.

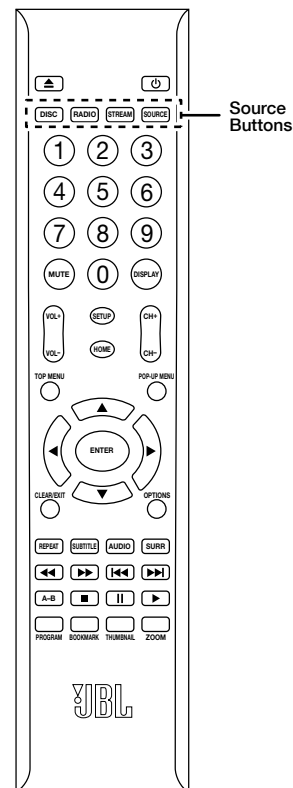

For complete information about using all of your Cinema BD100 system's features, download the *Cinema BD100 Home Theater System Owner's Manual* from www.jbl.com.



HARMAN HARMAN International Industries, Incorporated
8500 Balboa Boulevard, Northridge, CA 91329 USA

Made in P.R.C.

© 2012 HARMAN International Industries, Incorporated. All rights reserved.

JBL is a trademark of HARMAN International Industries, Incorporated, registered in the United States and/or other countries. Blu-ray Disc and BD-Live are trademarks of the Blu-ray Disc Association. The Bluetooth word mark and logo are registered trademarks and are owned by the Bluetooth SIG, Inc., and any use of such marks by HARMAN International Industries, Incorporated, is under license. DivX Certified® to play DivX® and DivX Plus® HD (H.264/MKV) video up to 1080p HD including premium content. DivX®, DivX Certified®, DivX Plus® HD and associated logos are trademarks of Rovi Corporation or its subsidiaries and are used under license. DLNA®, the DLNA Logo and DLNA CERTIFIED® are trademarks, service marks, or certification marks of the Digital Living Network Alliance. Manufactured under license from Dolby Laboratories. Dolby, Pro Logic and the double-D symbol are registered trademarks of Dolby Laboratories. DTS-HD Master Audio Essential. Manufactured under license under U.S. Patent Nos: 5,956,674; 5,974,380; 6,226,616; 6,487,535; 7,392,195; 7,272,567; 7,333,929; 7,212,872 & other U.S. and worldwide patents issued & pending. DTS-HD, the Symbol, & DTS-HD and the Symbol together are registered trademarks & DTS-HD Master Audio | Essential is a trademark of DTS, Inc. Product includes software. © DTS, Inc. All Rights Reserved. HDMI, the HDMI logo, and High-Definition Multimedia Interface are registered trademarks of HDMI Licensing LLC in the United States and other countries. Java, Java Powered and the Java Steaming Coffee Cup logo are trademarks or registered trademarks of Sun Microsystems, Inc., or its subsidiaries in the United States and other countries. Microsoft, Windows and Windows Media are registered trademarks of Microsoft Corporation in the United States and/or other countries.

Pandora is a registered trademark of Pandora Media, Inc.

Picasa is a trademark of Google, Inc.

WMA (Windows Media Audio) is a proprietary file format developed by Microsoft. This item incorporates copy-protection technology that is protected by U.S. patents and other intellectual-property rights of Rovi Corporation. Reverse engineering and disassembly are prohibited.

YouTube is a trademark of Google, Inc.

Features, specifications and appearance are subject to change without notice.

Part # 950-0481-001, Rev. A

www.jbl.com